

KGV

Powerful. Compact. Reliable

▶ KGV Gearbox

KGV Basic Solution

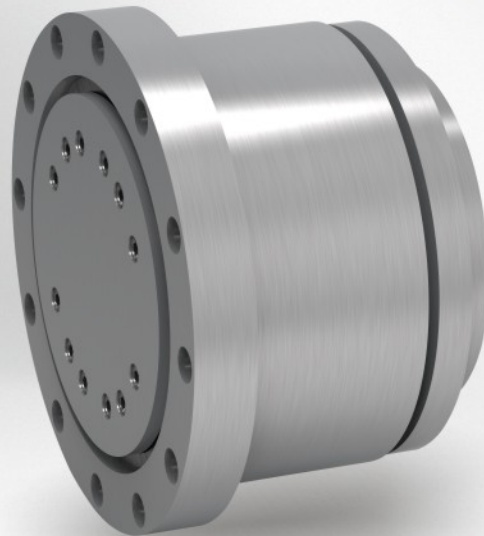

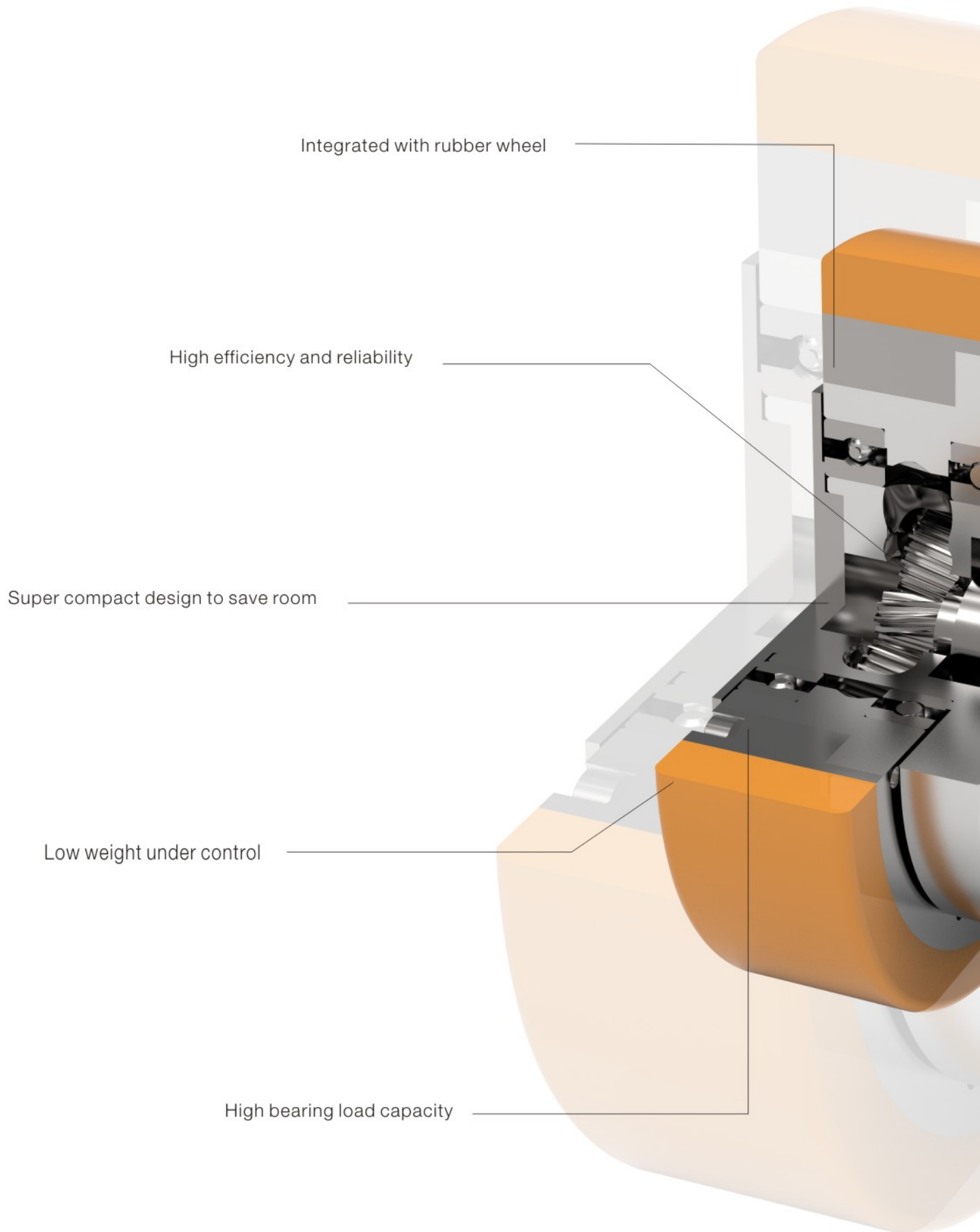

Integrated with rubber wheel

High efficiency and reliability

Super compact design to save room

Low weight under control

High bearing load capacity

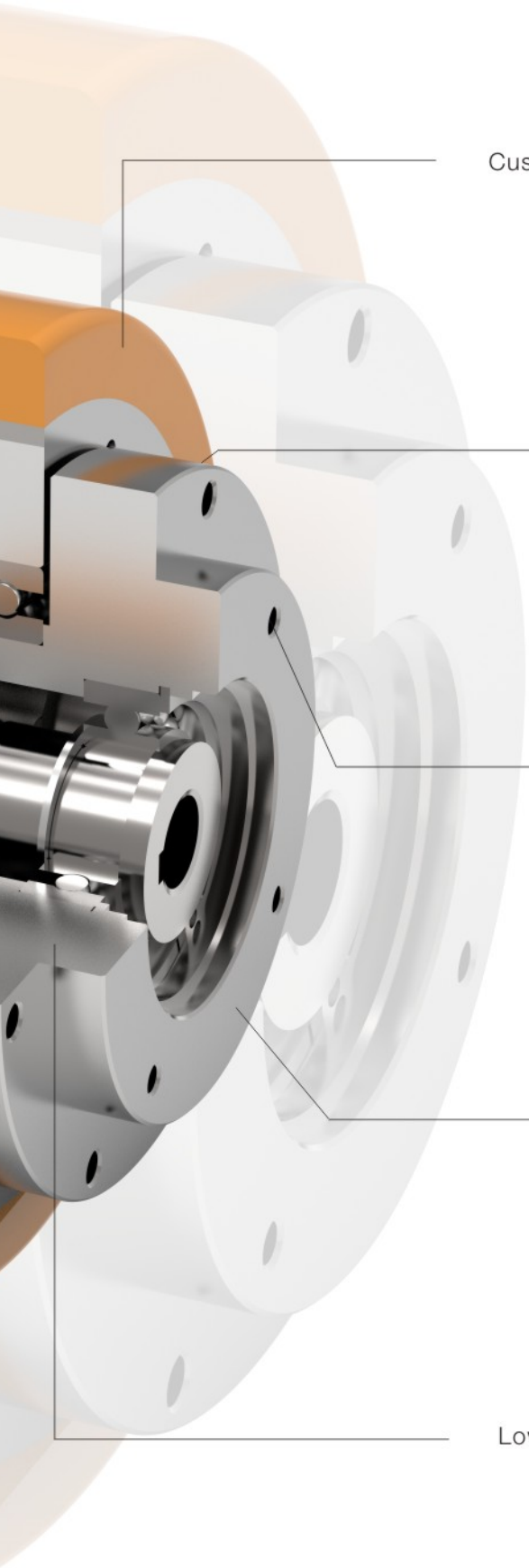

Customized design available

Maintenance free for whole service life

Cost-effective for solutions

Standard and modular options

Low running noise

KGV Gearbox Specification in Metric System

Model		KGV118	KGV138	KGV160	KGV190	Ratio	Stage	
Rated Output Torque	Nm	75	100	135	210	2	1	
		87	115	250	320	3		
		93	120	230	300	4		
		87	114	170	250	5		
		81	105	140	220	6		
		69	90	130	170	7		
		63	82	120	150	8		
		63	82	110	130	9		
		75	100	150	200	14		2
		75	100	145	190	16		
		75	100	140	180	18		
		75	100	130	160	20		
		87	115	230	300	21		
		87	115	230	285	24		
		87	115	220	270	27		
		93	120	250	320	28*		
		87	115	190	240	30		
		93	120	250	320	32*		
93	120	240	300	36*				
93	120	240	300	40*				
Emergency Stop Torque	Nm	2 times rated output torque						
Regular Applied Servo Motor	Watt	400~750	400~750	750~1000	1000~1500			
Max Radial Force	N	4000	8000	10000	12000			
Bearing Weight Capacity	kg	400	800	1000	1200			
Full loading Efficiency	%	95					1	
		93					2	
Service lifetime	h	15000						
Weight	kg	4.5	10.5	14	16.5		1	
		5.5	12	17.5	20		2	

Model		KGV118	KGV138	KGV160	KGV190	Ratio	Stage
Mass Moment of Inertia	kgcm ²	0.16	0.61	2.63	3.25	2	1
		0.14	0.48	1.79	2.74	3	
		0.13	0.47	1.53	2.71	4	
		0.13	0.47	1.5	2.62	5	
		0.13	0.45	1.4	2.62	6	
		0.13	0.44	1.32	2.62	7	
		0.13	0.44	1.32	2.57	8	
		0.13	0.44	1.32	2.57	9	
		0.127	0.127	1.63	2.56	14	
		0.127	0.127	1.75	2.56	16	
		0.12	0.12	1.53	1.75	18	
		0.075	0.075	1.49	1.5	20	
		0.075	0.075	1.49	1.49	21	
		0.064	0.064	1.3	1.3	24	
		0.064	0.064	1.3	1.3	27	
		0.064	0.064	1.3	1.3	28	
		0.064	0.064	1.3	1.3	30	
		0.064	0.064	1.3	1.3	32	
		0.075	0.075	1.3	1.5	36	
		0.075	0.075	1.32	1.49	40	
Running Noise	dB(A)	58	60	63	65		
Max Input Speed	min-1	6000	6000	6000	6000		
Rated Input Speed	min-1	3000	3000	3000	3000		
Protection Class		IP65					
Working Temperature	°C	minus 25 to 90					
Installation Position		Any					
Standard Lubrication		Lifetime Synthetic Lubrication Grease					
Low Temperature Lubrication		Lifetime Synthetic Lubrication Grease					
Backlash	arcmin	≤15	≤12	≤12	≤12		
Unit Gearbox Weight	kg	5	7.5	9.5	19		1
		6	8	10.5	22.5		2

KGV Gearbox Specification in British System

Model		KGV118	KGV138	KGV160	KGV190	Ratio	Stage	
Rated Output Torque	in.lb	664	885	1195	1859	2	1	
		770	1018	2213	2832	3		
		823	1062	2036	2655	4		
		770	1009	1505	2213	5		
		717	929	1239	1947	6		
		611	797	1151	1505	7		
		558	726	1062	1328	8		
		558	726	974	1151	9		
		664	885	1328	1770	14		2
		664	885	1283	1682	16		
		664	885	1239	1593	18		
		664	885	1151	1416	20		
		770	1018	2036	2655	21		
		770	1018	2036	2522	24		
		770	1018	1947	2390	27		
		823	1062	2213	2832	28*		
		770	1018	1682	2124	30		
		823	1062	2213	2832	32*		
		823	1062	2124	2655	36*		
		823	1062	2124	2655	40*		
Emergency Stop Torque	in.lb	2 times rated output torque						
Regular Applied Servo Motor	Watt	400~750	400~750	750~1000	1000~1500			
Max Radail Force	lb _r	899	1798	2248	2698			
Bearing Weight Capcity	lb _m	882	1764	2205	2646			
Full loading Efficiency	%	95						1
		93						2
Service lifetime	h	15000						
Weight	lb _m	9.9	23.2	30.9	36.4		1	
		12.1	26.5	38.6	44.1		2	

Model		KGV118	KGV138	KGV160	KGV190	Ratio	Stage	
Mass Moment of Inetia	10 ⁻³ in.lb.s ²	1.42	5.40	23.28	28.76	2	1	
		1.24	4.25	15.84	24.25	3		
		1.15	4.16	13.54	23.99	4		
		1.15	4.16	13.28	23.19	5		
		1.15	3.98	12.39	23.19	6		
		1.15	3.89	11.68	23.19	7		
		1.15	3.89	11.68	22.75	8		
		1.15	3.89	11.68	22.75	9		
		1.12	1.12	14.43	22.66	14		2
		1.12	1.12	15.49	22.66	16		
		1.06	1.06	13.54	15.49	18		
		0.66	0.66	13.19	13.28	20		
		0.66	0.66	13.19	13.19	21		
		0.57	0.57	11.51	11.51	24		
		0.57	0.57	11.51	11.51	27		
		0.57	0.57	11.51	11.51	28		
		0.57	0.57	11.51	11.51	30		
		0.57	0.57	11.51	11.51	32		
		0.66	0.66	11.51	13.28	36		
		0.66	0.66	11.68	13.19	40		
Running Noise	dB(A)	58	60	63	65			
Max input Speed	min ⁻¹	6000	6000	6000	6000			
Rated input Speed	min ⁻¹	3000	3000	3000	3000			
Protection Class		IP65						
Working Temperature	°C	minus 25 to 90						
Installation Position		Any						
Standard Lubrication		Lifetime Synthetic Lubrication Grease						
Low Temperature Lubrication		Lifetime Synthetic Lubrication Grease						
Backlash	arcmin	≤15	≤12	≤12	≤12			
Unit Gearbox Weight	lb _m	11	16.5	21	42		1	
		13.2	17.6	23.2	50		2	

KGV Gearbox Dimensions

KGV-118-1 stage

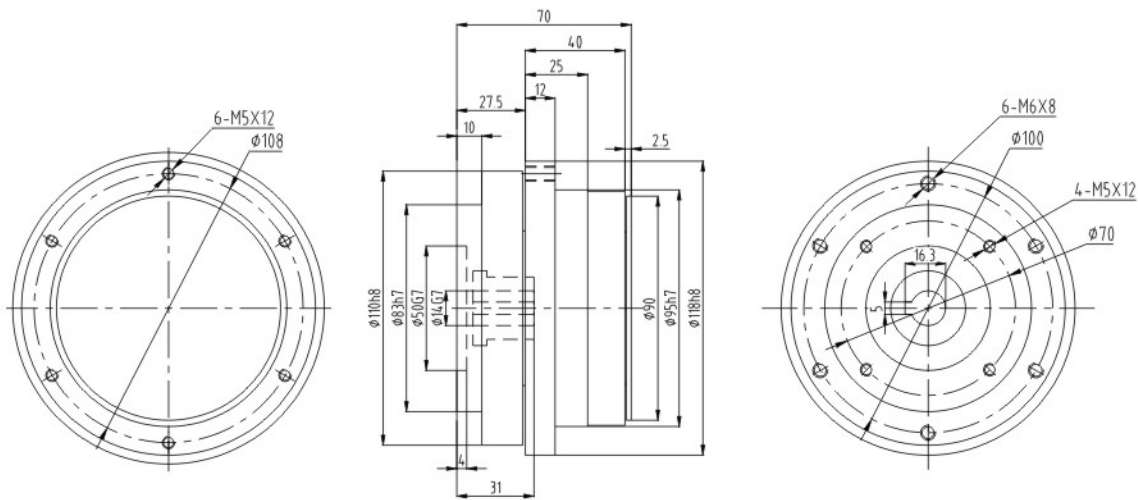

KGV-118-2 stages

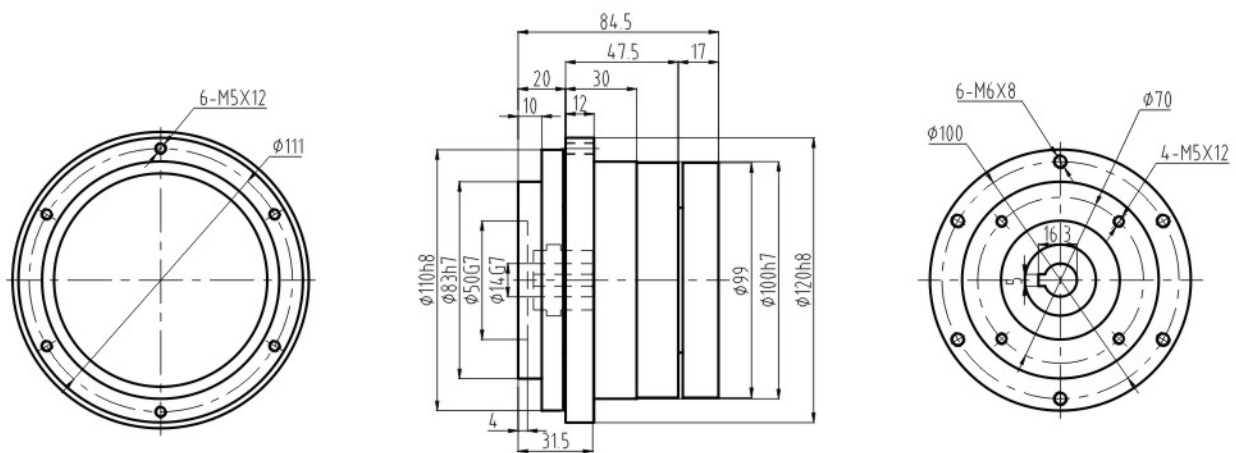

KGV-138-1 stage

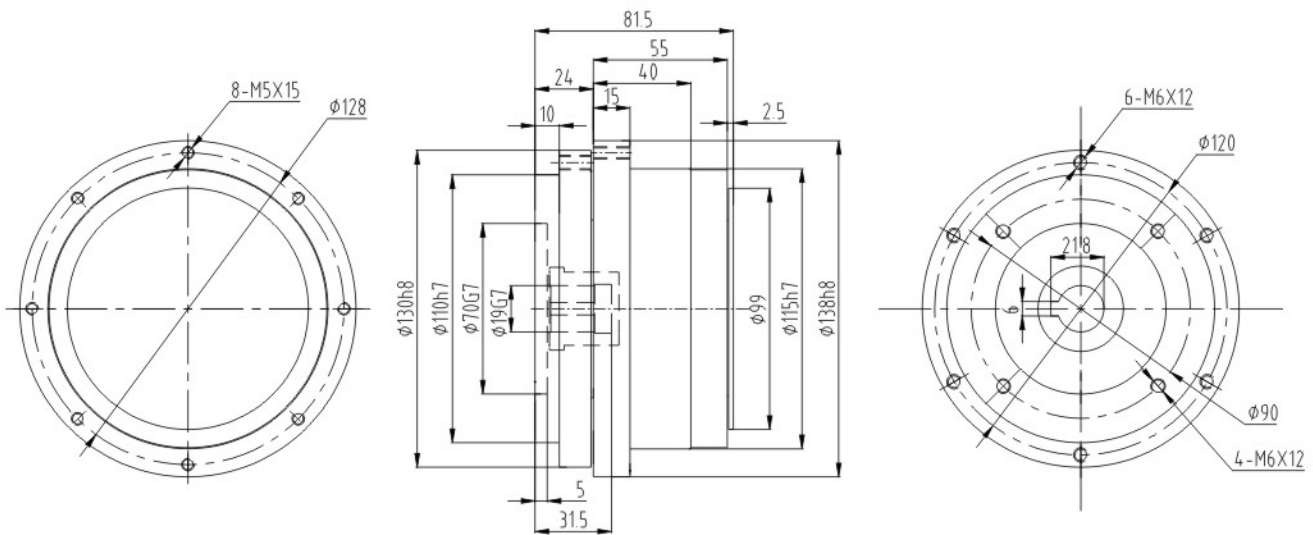

KGV-138-2 stages

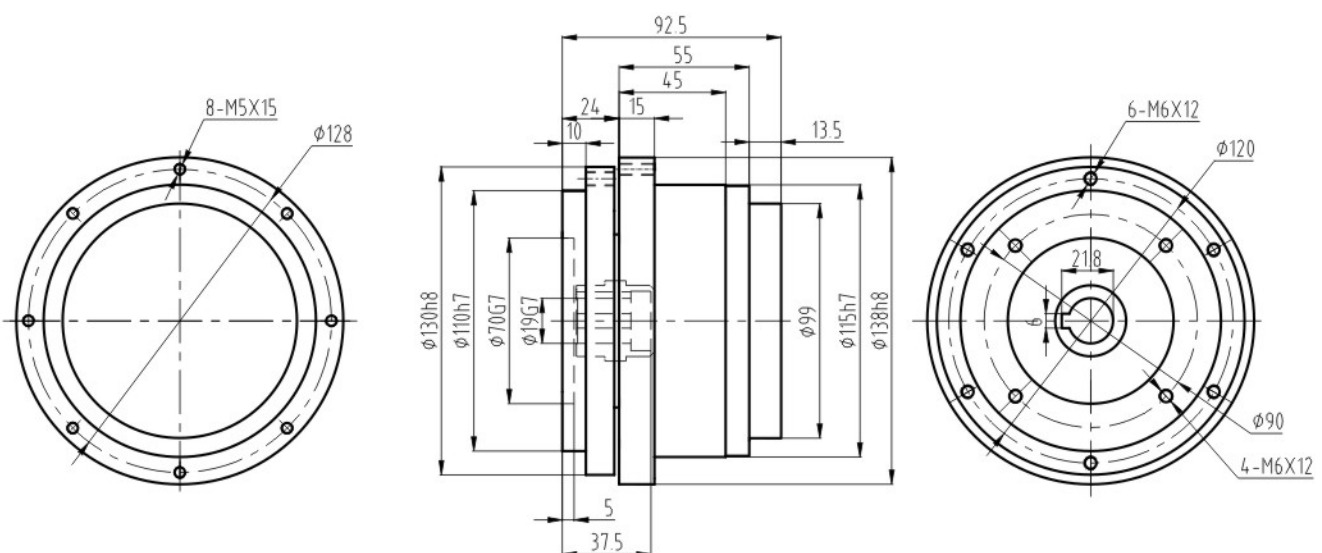

KGV Gearbox Dimensions

KGV-160-1 stage

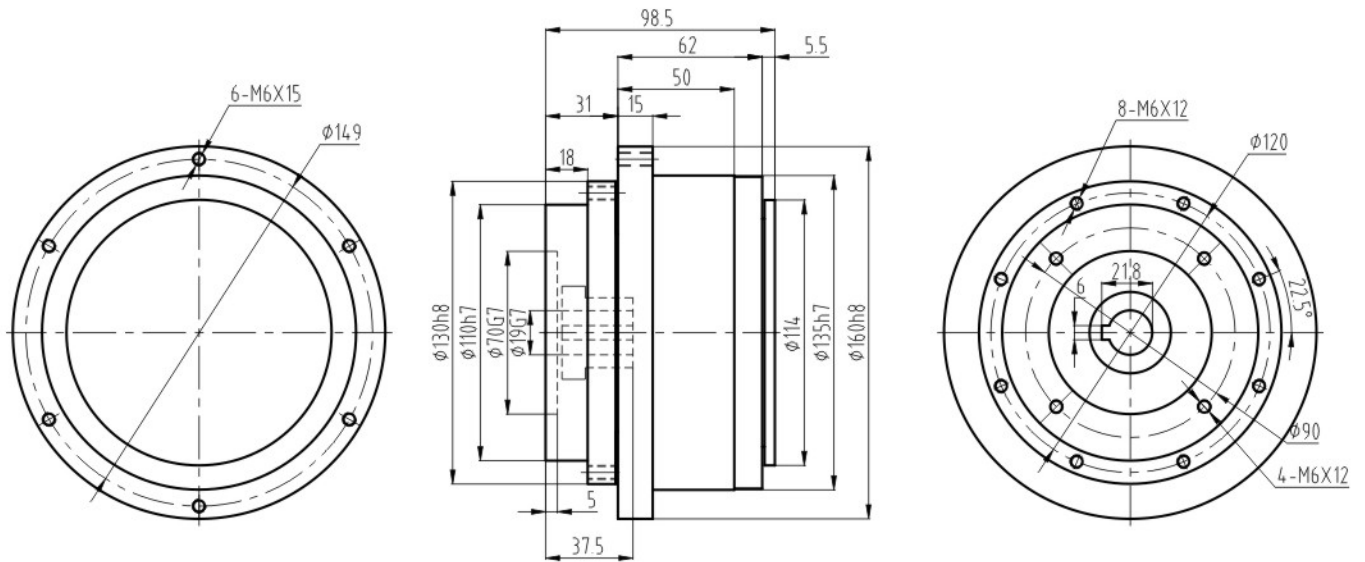

KGV-160-2 stages

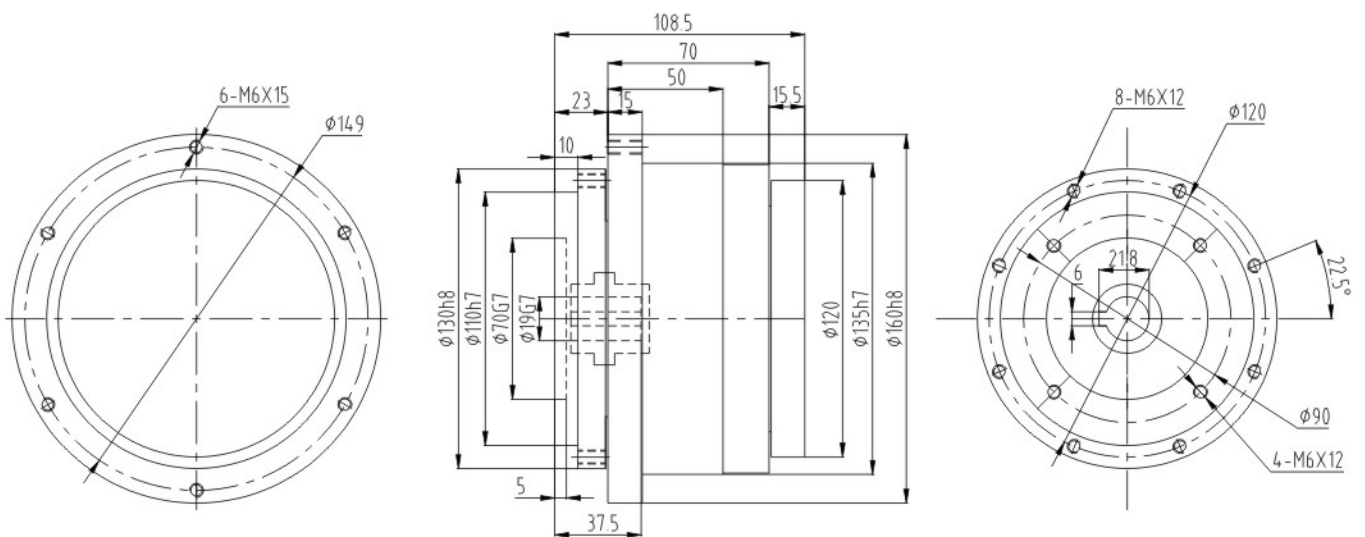

KGV-190-1 stage

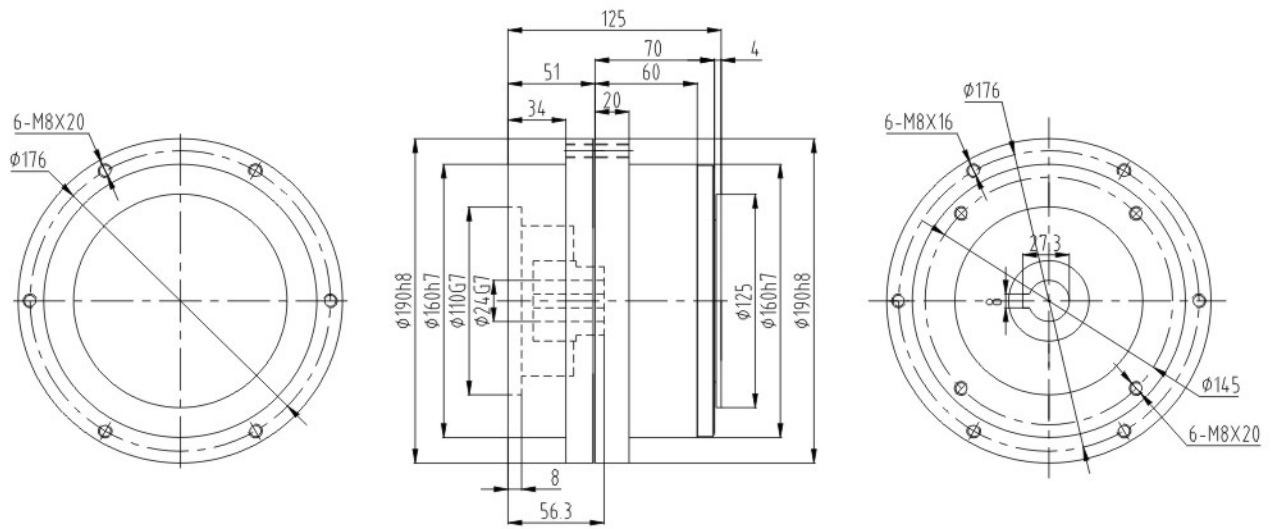

KGV-190-2 stages

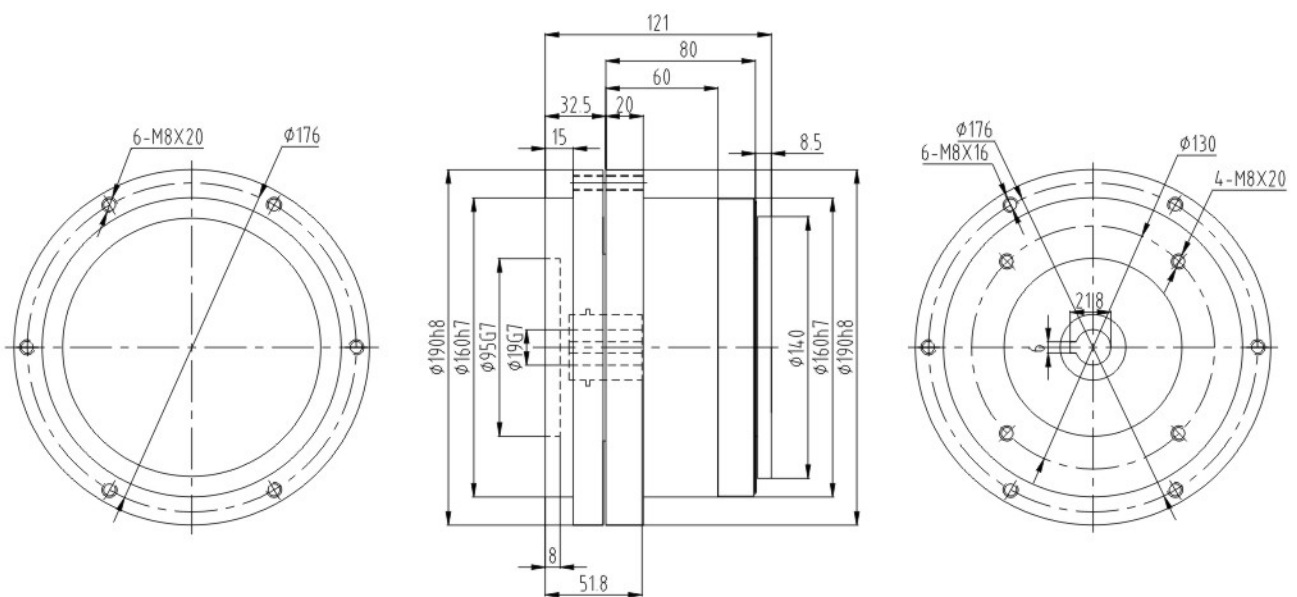

Technical Memo

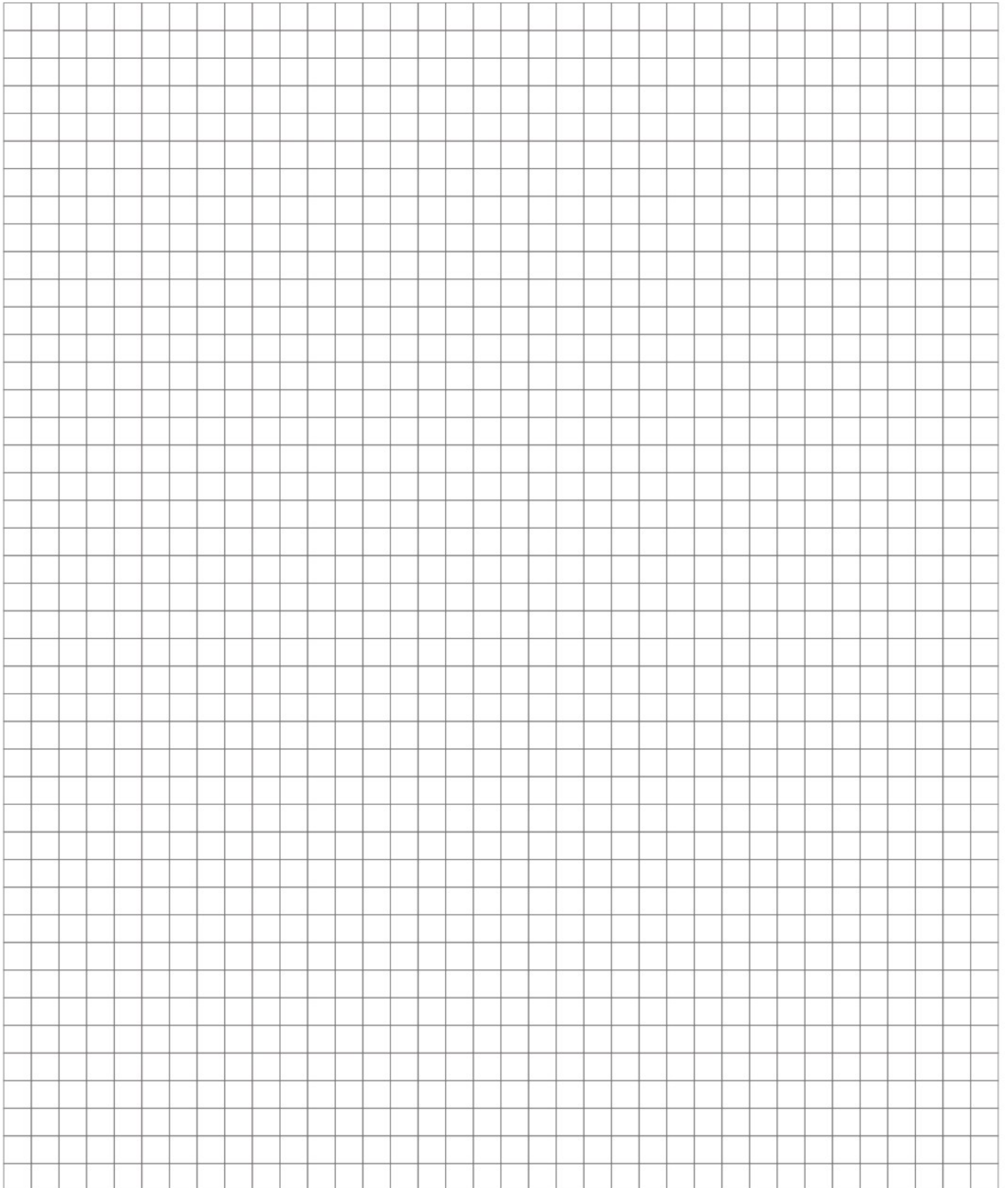
A large grid of graph paper, consisting of 20 columns and 40 rows of small squares, intended for technical drawing or calculations.